

IRON RETAINING GLAND M.J. RESTRAINT			
NOMINAL PIPE SIZE	WEDGES QUANTITY	BOLTS QUANTITY	PRESS RATING
6"	3	6	350
8"	4	6	350
12"	8	8	350
16"	12	12	350

8" SIZE SHOWN 6" & 12" SIMILAR IRON RETAINING GLAND M.J. RESTRAINT

LR (MIN. LENGTH OF RESTRAINT EACH DIRECTION OF THRUST IN LINEAR FEET)
Based on 200 psig pressure, Safety Factor of 2.0:1, BARE DI PIPE AND ML Soil, 3.5' cover
Chart does not apply to pipes wrapped in polyethylene wrap

PIPE SIZE	VALVES DEAD ENDS TEES	90° ELBOWS	45° ELBOW & CROSSES	22-1/2° ELBOWS	REDUCER
6"	55'	31'	13'	7'	8"X2" 67'
8"	72'	40'	17'	8'	8"X6" 30'
12"	102'	57'	24'	12'	12"X8" 54'
16"	130'	72'	30'	15'	12"X8" 54' 16"X8" 95'

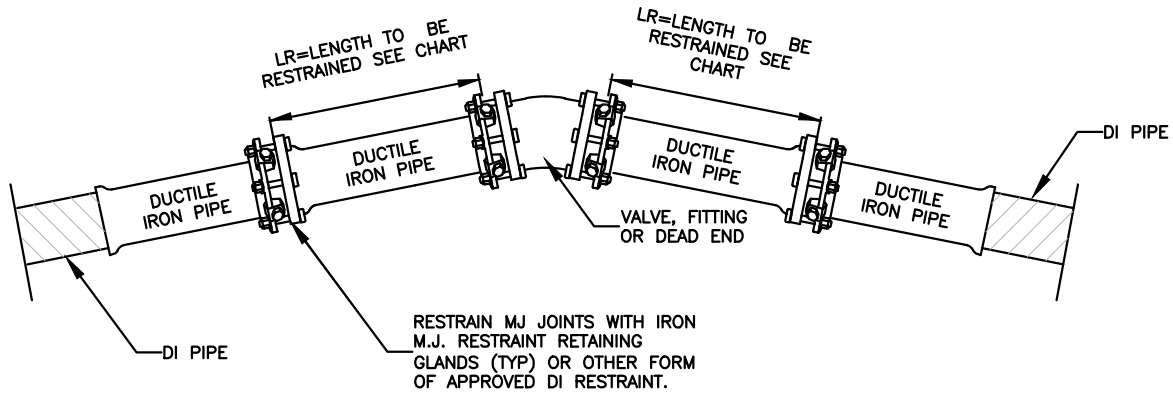

DATE: 07/07/2019 WD DWG. NO. 4-1

SCALE: NOT TO SCALE

City of Hendersonville Engineering Department
305 Williams Street
Hendersonville, NC 28792
(828) 697-3000 (office)

www.cityofhendersonville.org

DUCTILE IRON PIPE RESTRAINT DETAIL

SHEET 1 OF 2

